



HEALTH & SAFETY WARNING

As the Heat Pump contains electrical and rotational equipment, it is recommended that **ONLY** competent persons carry out any work on this type of machine (see guarantee). Isolate electrically before entering machine or removing panels.

This appliance is not intended for use by persons (including children) with reduced physical, sensory or mental capabilities, or lack of experience and knowledge, unless they have been given supervision or instruction concerning use of the appliance by a person responsible for their safety. Children should be supervised to ensure that they do not play with the appliance

INSTALLATION - WALL MOUNTING ALL MODELS

1. Remove machine from packaging and locate fixing bracket.

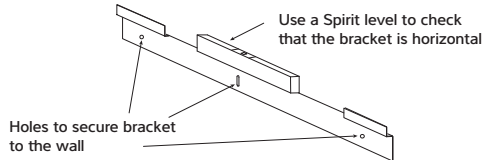

- Place bracket on wall in required position. Drill one hole in the wall \varnothing 6.0mm (no. 10) by 60mm deep. Use the wall plug provided to fix the bracket to the wall. Using the bracket as a template mark positions for other holes. Using a spirit level check that the bracket is level. Drill holes \varnothing 6.0mm (no. 10) by 60mm deep. Insert wall plugs and screw bracket in place. Note. The wall plugs provided with the dehumidifier are suitable for fixing to a load bearing wall
- Check all screws are tight.
- The dehumidifiers are heavy and may require two or three people to lift the dehumidifier on to locating lugs on wall bracket.
- Remove front cover as shown FIG 1.

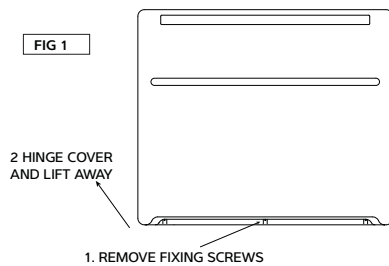

- Locate pipe from drip tray and run it away to waste. A short length of 10mm pipe is provided which should be led into a fixed waste pipe. Two pipe outlet holes are provided, one to rear of unit, one below the unit.
- Electrical supply to the unit must be sized according to data on serial number label paying special attention to I.E.E. regulations latest edition regarding the special conditions governing electrical supply to machines in potentially damp areas. The machine should be installed in accordance with EMC2004/108/EC.
- The electrical supply should be connected to the terminal block mounted on the side of the bracket supporting the compressor. Brown/red to 'live', blue/black to neutral and earth to the stud provided.
- Fan mode switch can be set to cycle fan when humidistat senses demand but should be set to continuous to promote good air circulation and reduce condensation. Note that on models fitted with LPHW the fan(s) will start automatically whenever there is an air heating demand. On 'X' models fan(s) will stop during defrost cycle.
- The humidity of the environment is controlled by a humidity sensor. The dial for this is located on the bottom of the dehumidifier, on the left hand side for a DH30/33 or the right hand side for a DH50/55. Turning the dial anti-clockwise gives maximum dehumidification.

'RH' MODEL WITH HEAT RECLAIM TO WATER

- Connect water circuit piping to 15mm stubs projecting from side of machine as per diagram below:
- It is recommended that isolating valves are fitted to enable isolation of the machine in the event of service. Complete water circuit as per diagrams overleaf. (a) Circulating pump must be sized to take into account the design flow rate of the machine plus the water system resistance. For Pressure drops see data section.

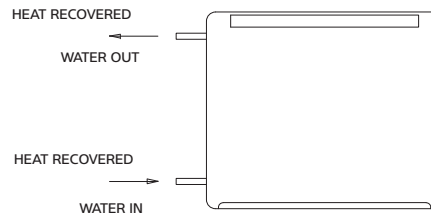

MODELS WITH LPHW FITTED

- Connect water circuit piping to 15mm stubs projecting from side of machine as per diagram below:
- It is recommended that isolating valves are fitted to enable isolation of the machine in the event of service. Complete water circuit as per diagrams overleaf. (a) Circulating pump must be sized to take into account the design flow rate of the machine plus the water system resistance. For Pressure drops see data section.

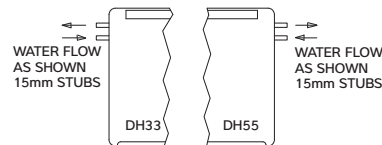

12V REMOTE HUMIDISTAT, THERMOSTAT, & REMOTE ON/OFF CONNECTIONS (THESE OPTIONS NEEDS TO BE SPECIFIED WHEN ORDERING DEHUMIDIFIER)

- Remove cover from dehumidifier as shown in Fig 1. REMOTE HUMIDISTAT
Remove link wire from mains in terminal block marked 'Remote Humidistat' and connect remote humidistat as shown below, ensure dial on internal humidistat is set fully anti-clockwise (ie maximum dehumidification). REMOTE ON/OFF
When connecting the Remote On/Off Switch remove the link from the mains in terminal block marked Remote On/Off. Connect the switch as shown below.

FIG 2 WIRING DIAGRAM

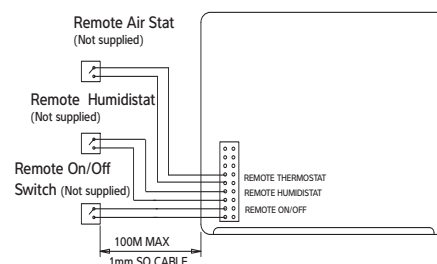

'P' MODELS WITH RESISTANCE HEATER

16. Connect remote air thermostat as shown above to mains in terminal block marked Remote Thermostat
17. Ensure safety thermostat(s) below are set, ie push red button(s).

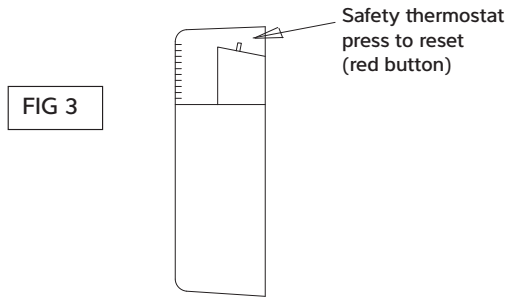

18. Replace front cover, turn on electrical supply and turn humidistat towards 20%. (Unless remote humidistat fitted, see note 15 above) unit fan will start, followed 6 minutes later by the compressor.
20. It is recommended that the fan mode switch is set to continuous, as in cycle mode the fan and heaters only run together if there is a demand for dehumidification.

MODEL		DH30A & DH30AX	DH30AP & DH30AXP	DH30ARH	DH33A & DH33AX	DH33ARH	DH50A & DH50AX	DH50AP & DH50AXP	DH50ARH	DH55A & DH55AX	DH55ARH
SUPPLY		230V 50Hz									
FUSE	Amps	10	20	10	10	10	13	32	13	13	13
NOMINAL RUNNING AMPS	Amps	3.4	11.7	3.4	3.4	3.4	5.6	22.3	5.6	5.6	5.6
FULL LOAD AMPS	Amps	4.4	12.7	4.4	4.4	4.4	7.5	24.2	7.5	7.5	7.5
COMPRESSOR LRA	Amps	15.8	15.8	15.8	15.8	15.8	30	30	30	30	30
AIR FLOW	m ³ /h	700	700	700	440	440	1280	1280	1280	740	740
NOISE LEVEL @3m	dB/A	52	52	52	48	48	56	56	56	48	48
WATER FLOW RATE	L/min	n/a	n/a	10	n/a	10	n/a	n/a	14	n/a	14
PRESSURE DROP	m hd	n/a	n/a	1.6	n/a	1.6	n/a	n/a	1.5	n/a	1.5
LPHW FLOW RATE	L/min	n/a	n/a	n/a	5.0	5.0	n/a	n/a	n/a	5.0	5.0
LPHW PRESSURE DROP	m hd	n/a	n/a	n/a	1.1	1.1	n/a	n/a	n/a	1.8	1.8
LPHW VOLUME	Litres	n/a	n/a	n/a	0.5	0.5	n/a	n/a	n/a	0.85	0.85
DIMENSIONS (UNPACKED)											
HEIGHT	mm	655	655	655	655	655	655	655	655	655	655
WIDTH	mm	780	780	780	780	780	1245	1245	1245	1245	1245
DEPTH	mm	250	250	288	250	288	250	250	288	250	288
WEIGHT	kg	40	40	45	40	45	60	60	65	60	65
HERMETIC SYSTEM											
REFRIGERANT CHARGE 'A' DEHUMIDIFIERS	kg R407c	0.5	0.5	1.04	0.5	1.04	0.75	0.75	1.64	0.76	1.65
REFRIGERANT CHARGE 'AX' DEHUMIDIFIERS	kg	0.5	0.5	N/A	0.5	N/A	0.8	0.8	N/A	0.8	N/A

R407c Global Warming Potential (GWP) 1774

PLUMBING CIRCUITS HEAT RECOVERY MODELES 'RH'

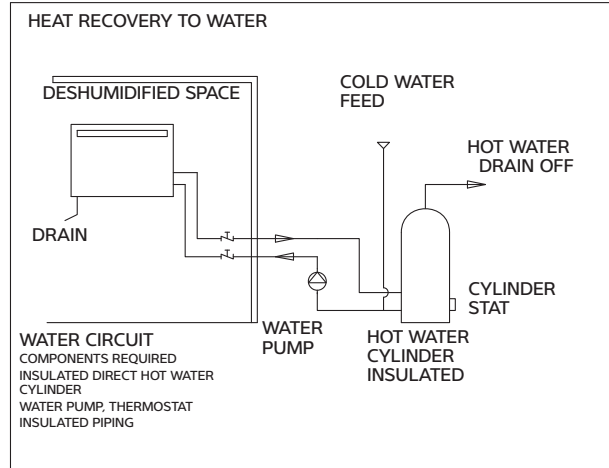
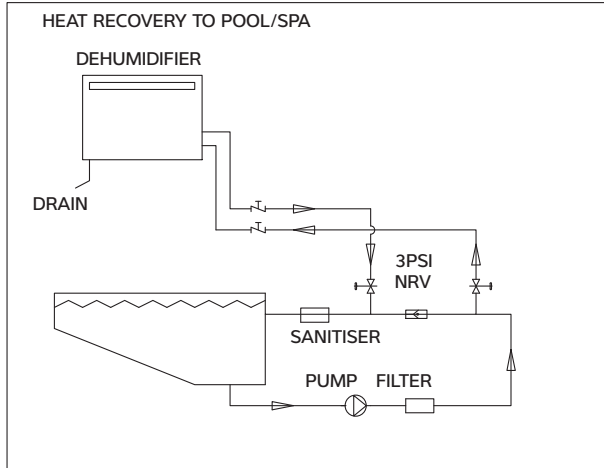

ELECTRICAL SUPPLY CIRCUITS

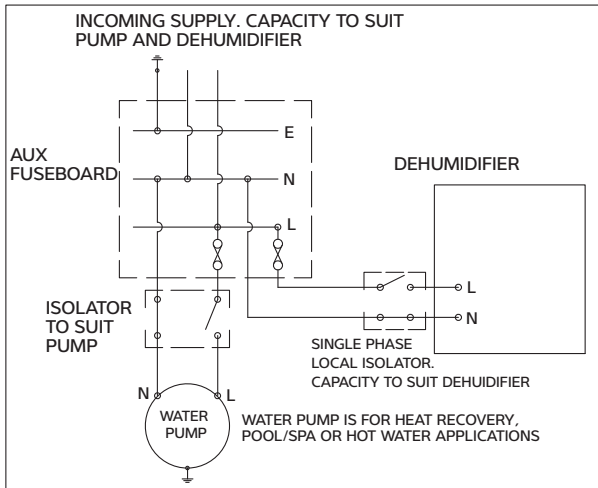

LPHW PLUMBING SCHEMATIC

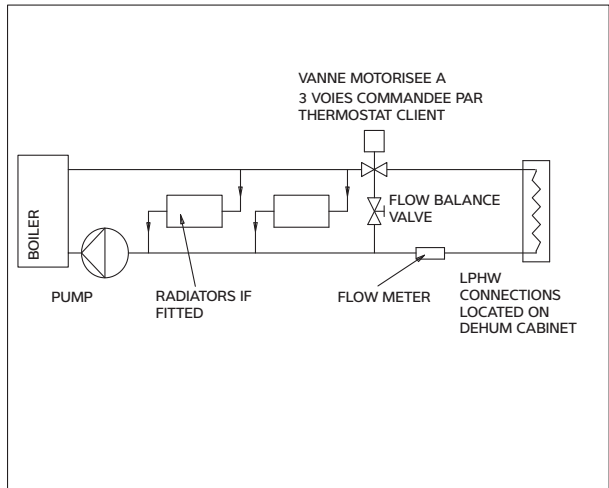

USER CHECK LIST

OPERATION

A recommended humidistat setting (50-60% RH) is a mid way point on the dial (Green segment on label).

Minimum Air Temp DH30/33/50/55 A = 15°C

Minimum Air Temp DH30/33/50/55/ AX = 0°C.

Note on "X" models the fan stops during defrost.

On machines with resistance heaters DH30/50 "P" heating control is governed by the remote mounted air thermostat, adjust to desired air temp, heater will run automatically as required.

On machines with LPHW, fans will start automatically as required.

MAINTENANCE

a) Ensure air inlets/outlets are kept clear and clean. Filter kits are available.

b) Wipe clean with damp cloth or cleaning fluid suitable for fibreglass and/or PVC.

c) Ensure drain line is kept clear.

Note: Three reply paid Warranty Registration Card must be returned to ensure the correct warranty is given. If you do not find a Registration Card with your machine please contact CALOREX Service Department giving your name, address, and the serial number of your machine. A card will be sent to you for completion.

HEALTH AND SAFETY WARNING

As the heat pump contains electrical and rotational equipment, it is recommended that ONLY competent persons carry out any work on this type of machine (see guarantee).

Isolate machine electrically before entering machine or removing panels.

MACHINE NOT RUNNING AT ALL

CHECK THE FOLLOWING

- 1 Is the supply switched on?
- 2 Is the supply fuse healthy?
- 3 Turn humidistat knob fully anti-clockwise.
- 4 Check air inlets and outlets for obstructions.
- 5 ON P models reset the thermostat(s) see FIG 2.
- 6 If after carrying out the above and waiting one hour, the machine does not start, phone for service.

MACHINE FAN ONLY RUNNING

- 7 Turn humidistat knob fully anti-clockwise.
- 8 Check air inlets and outlets for obstructions, if after 30 minutes the machine has not restarted, phone for service.

WATER LEAKING FROM BASE OF UNIT

- 9 Check connection from machine to drain for blockages and clear accordingly, check fall is adequate.
- 10 Check the machine is level, both vertically and horizontally.

The user check list should be carried out before initiating a service call. Do not attempt to interfere with any internal control settings as these have been factory calibrated and sealed.

If in doubt or if advice is required, contact Calorex Service Department Telephone (01621) 857171 or 856611

PLEASE LEAVE INSTRUCTIONS FOR USER