

INSTRUCTION

Fire Protection Controller(FPC)

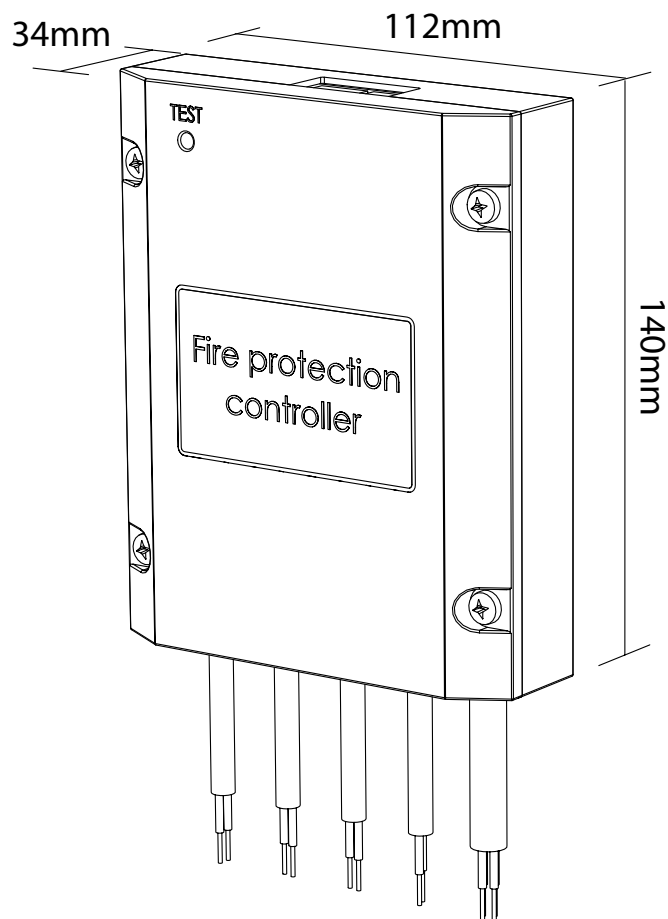

Introduction

Content

This service manual covers the following main topics:

Introduction	2
Installation.....	3
Commissioning	5
Technical data.....	7

Product no.

This Installation manual covers Dantherms FPC with the following product no.: 097387.
Product number for this service manual: 098712

Reservations

Dantherm reserves the right to make changes and improvements to the product and the service manual at any time without prior notice or obligation.

General Introduction

The FPC is a fire protection controller, which can control one fire damper. It is designed for use with Belimo BFL230-T/ BFL24-T or similar fire damper motor. The fire damper motor is connected directly to the FPC. FPC can be controlled via commands over the RS 485 Modbus communication line. Each FPC connected to the RS 485 communication line must be addressed individually (DIP switch on PCB). It is possible to connect max. 4 FPC to one unit. The FPC s are equipped with LED lamps indicating damper position and status. An extra input for a thermostat or smoke detector is provided.

Benefits

- Easy cable installation.
- Individual alarms and damper status.
- Additional thermostat or smoke detector input.

Overview

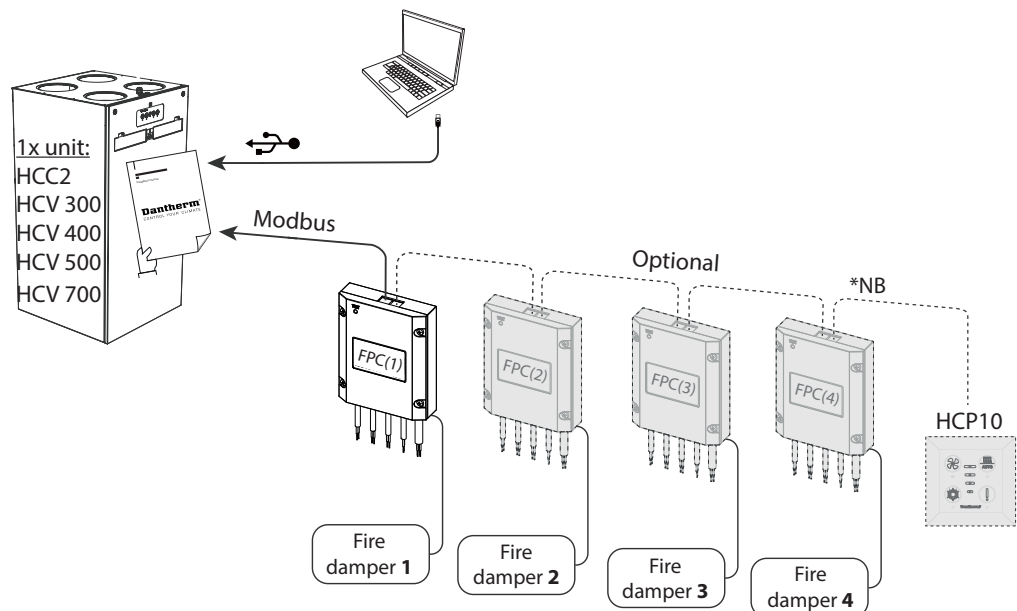

***NB:** Connect HCP10 display, if the unit is hidden away or is delivered without display (as e.g. HCC2)

Installation

Responsibility of the installer

It is the responsibility of the installer to ensure the conformity of the FPC setup towards national regulations and standards.

Installation example 1

This illustration shows how to connect the fire damper without any external monitoring. Remember to place the jumper.

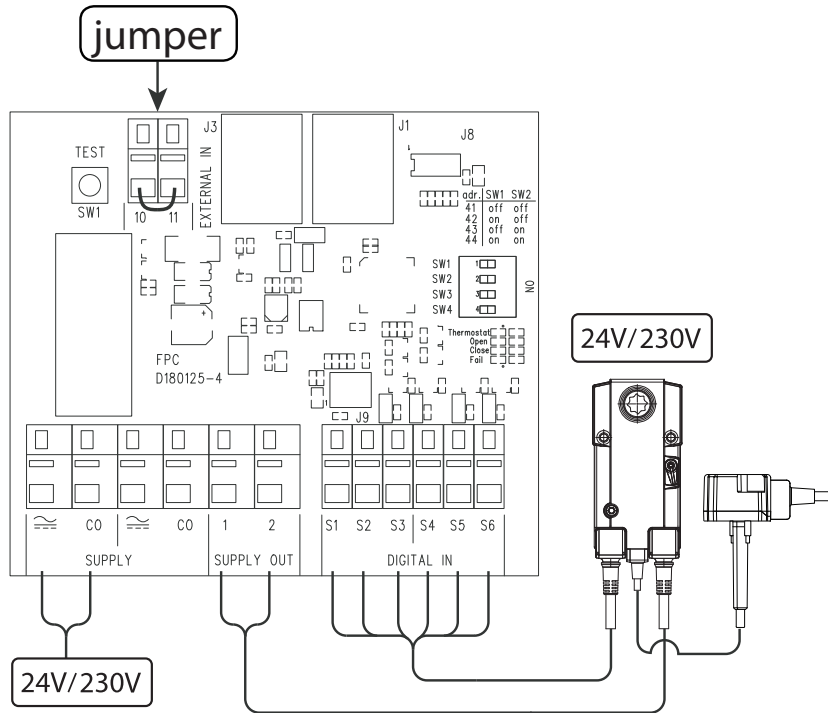

Installation example 2

This illustration shows how to connect the fire damper and external monitoring as e.g. a fire thermostat or automatic fire alarm (AFA) (the switch is illustrated in alarm mode).

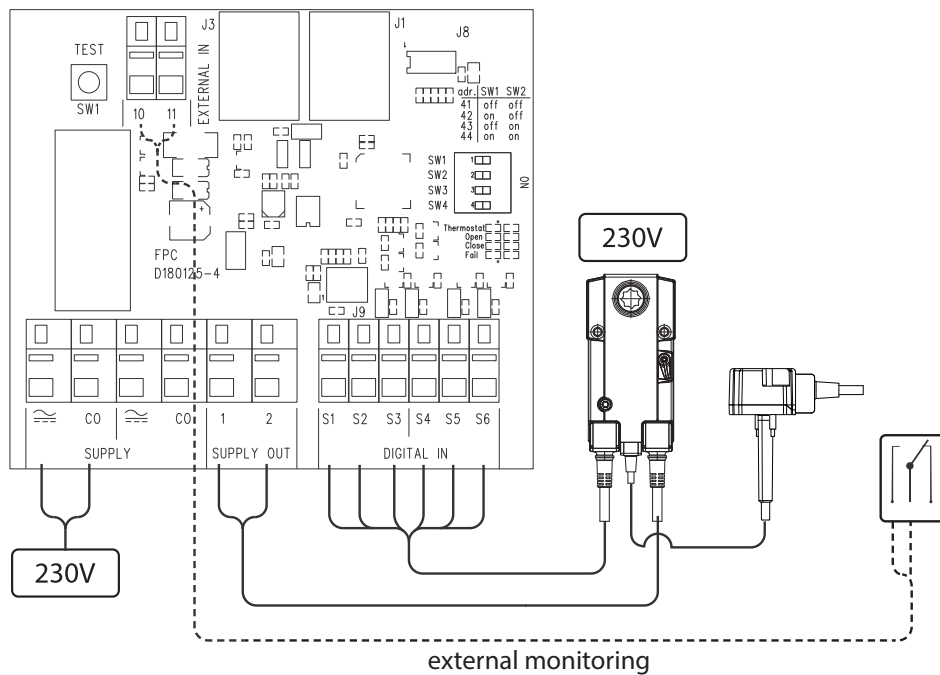

Installation, continued

Installation example 3

This illustration shows how to connect the fire damper and a smoke detector (the switch is illustrated in alarm mode).

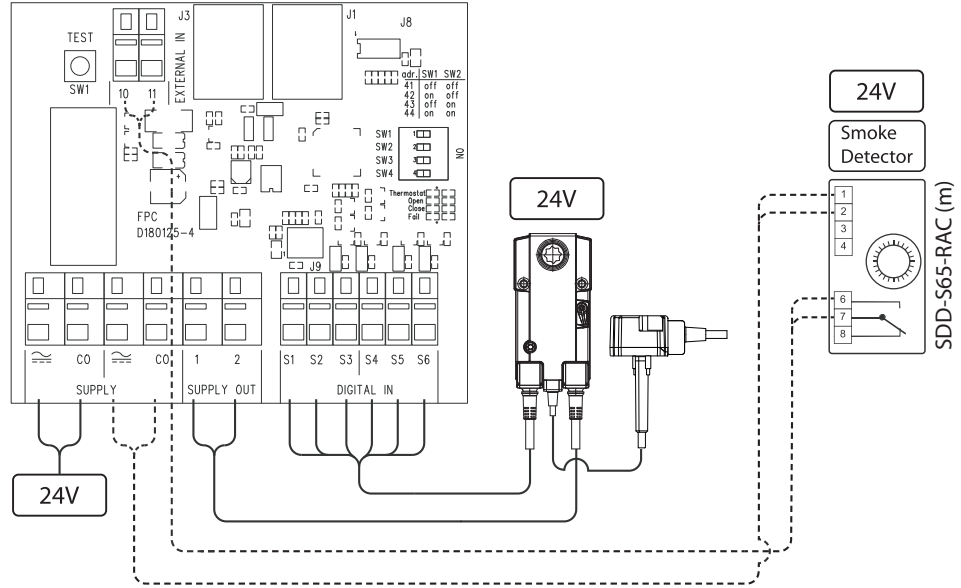

PCB DIP switches

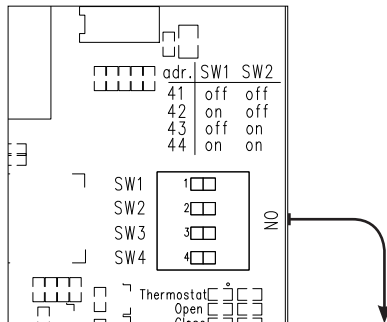

Modbus address settings

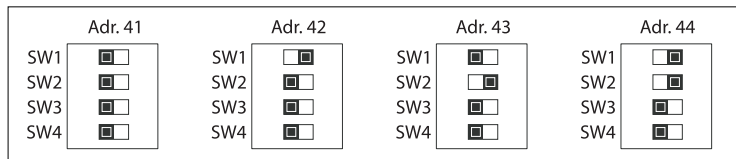

Commissioning

Activating

The connected fire damper will automatically be activated when the unit is turned on. If more FPC's are connected, each FPC must be addressed individually. The PC-tool displays, how many FPC's are connected (Under SETTINGS/ FIRE DAMPER).

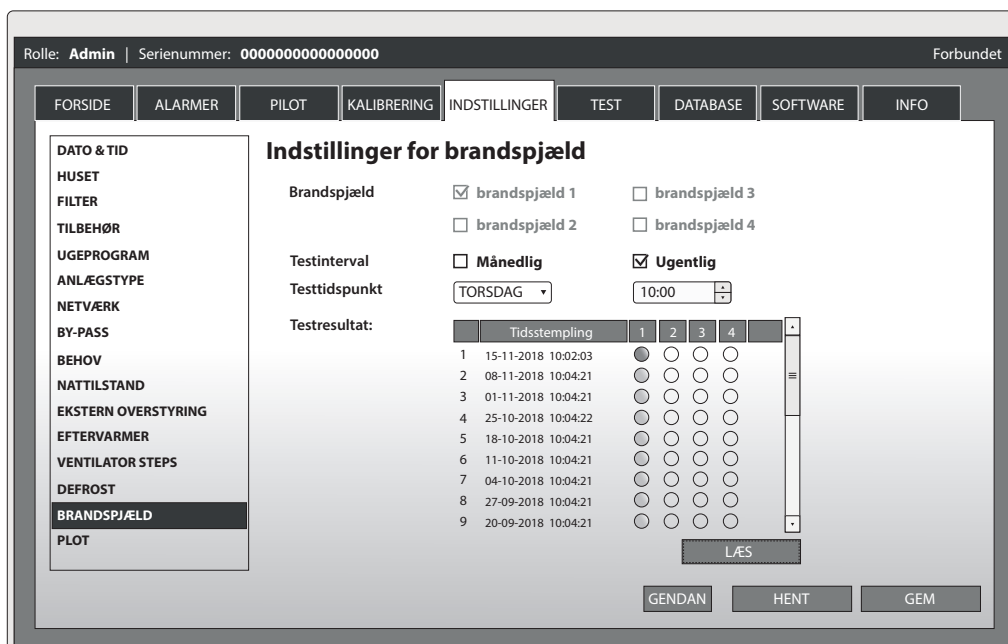

Deactivating

Deactivate a FPC by following these steps:

1. Switch off the ventilation unit.
2. Disconnect cable from ventilation unit to FPC.
3. Switch on the ventilation unit again.
4. Deactivate the disconnected FPC under SETTINGS/ FIRE DAMPER and press the SAVE button.

Automatic test

The test will automatically start once a week or once a month, depending on the settings. Adjust the settings and choose the weekday and desired start time of the automatic test under SETTINGS/ FIRE DAMPER. If monthly test interval is chosen, the test will automatically be performed on the first coming chosen weekday every month.

The result of every test is saved in a log, containing the last 20 tests. The testlog can be displayed by pressing the READ button.

- Green light indicates that the test was succesful.
- Red light indicates that the test failed.

Commissioning, continued

Manual test

See the current mode of the activated fire damper under TEST/ FIRE DAMPER. It is also possible to activate a manual test, equivalent to the automatic test.

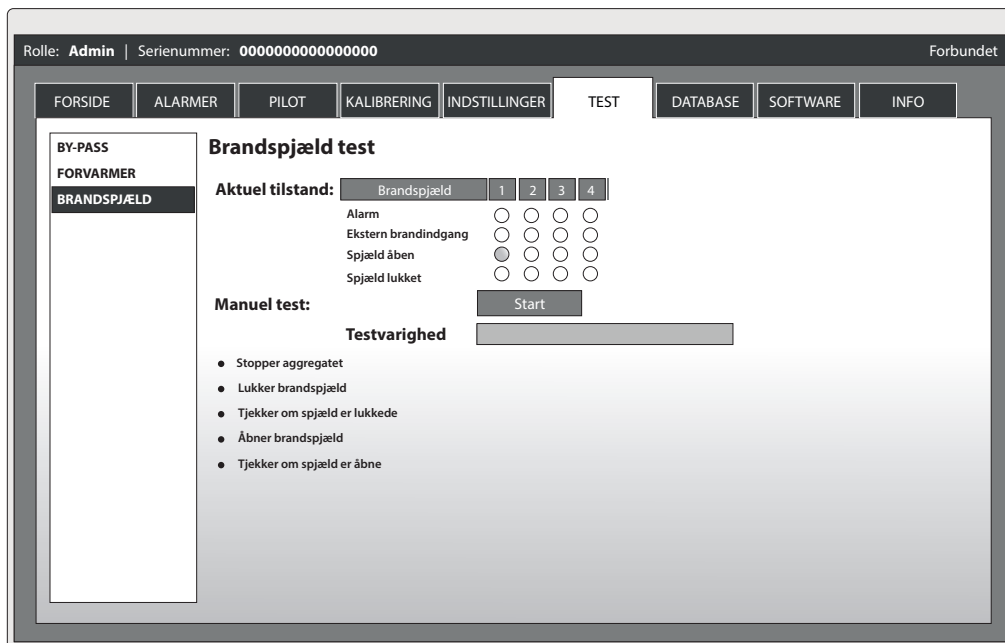

Alarms

FPC can activate following alarms:

Alarm	Name	Activated by
E14	Fire alarm	Broken connection for EXTERNAL IN
E16	Fire damper failure	<ul style="list-style-type: none"> • Missing communication to the activated FPC. • Wrong position of fire damper during operation. • Wrong position of fire damper during test.

Technical data

Technical data

Power	Unit	Connection
Damper motor supply	24V/230V AC	Terminal 1&2 . Wago cage clamp
Position feedback (Digital input for dry contact use) SPDT connections for open/close feedback	12V/12mA	Terminal S1-S6. Wago cage clamp
Thermostat/smoke detector (for dry contact use)	12V /12mA	Terminal 10-11. Wago cage clamp
RS 485 communication line: (Modbus RTU protocol)	12V/A-B	RJ 11 6P6C
Logic power consumption		max. 100mA

Dimensions

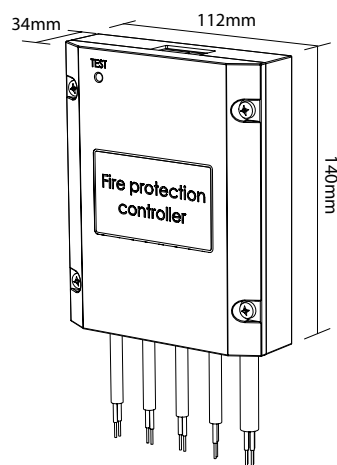



Dantherm A/S
Marienlystvej 65
7800 Skive
Denmark
support.dantherm.com



098712

Dantherm can accept no responsibility for possible errors and changes (en)
Der tages forbehold for trykfejl og ændringer (da)
Irrtümer und Änderungen vorbehalten (de)
Dantherm n'assume aucune responsabilité pour erreurs et modifications éventuelles (fr)

