

DA Montagesæt, vandvarmeblade

Introduktion

Vandvarmebladen passer til HXV 5.

Vandvarmebladen tilsluttes ikke til styringen, men har i stedet sin egen termostat (som en normal radiator)

Illustration

Dette illustrerer:

- Vandvarmeblade
- Beslag
- Isolering

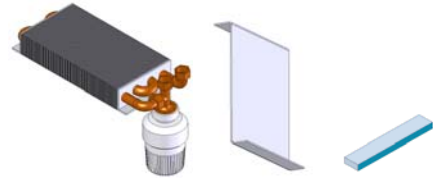

Værktøj

Der er ikke brug for specialværktøj.

Fremgangsmåde

Følg denne fremgangsmåde for at montere vandvarmebladen:

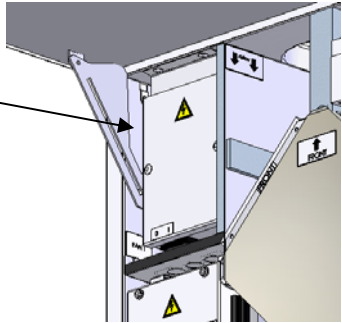
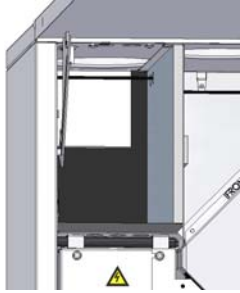
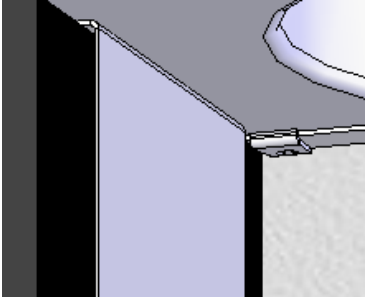
Trin	Handling
1	<p>Åbn frontlågen og afmonter varmeelementet</p> 
2	<p>Monter beslaget på bagvæggen af HXV 5 ved at presse den øverste kant ind over isoleringen</p>  

Fortsættes på næste side

Montagesæt, vandvarmeplade, *fortsat*

Fremgangsmåde,
fortsat

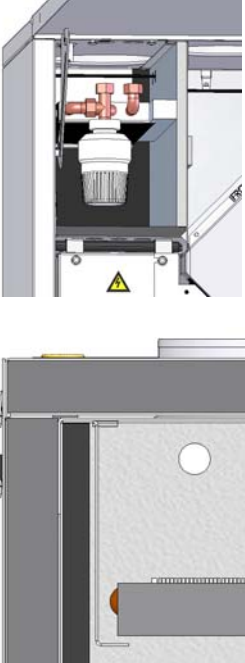
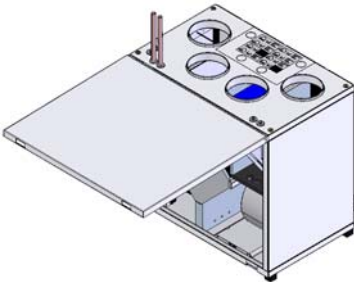
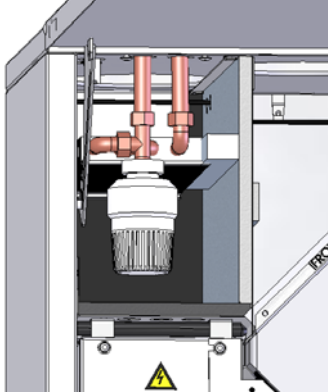
Trin	Handling
3	<p>Monter vandvarmepladen i HXV 5</p> <p>Det bageste af vandvarmepladen skal hvile på beslaget (tegningen viser det set fra siden)</p> 
4	<p>Pres to 1/2" rør gennem åbningerne i toppen</p> 
5	<p>Fastgør fladen til de to 1/2" rør</p> 
6	<p>Luk frontlågen og start HXV 5</p>

EN Mounting kit, water heating coil

Introduction

The water heating coil is applicable for the HXV 5.

The water coil will not be connected to the controller, but will have its own thermostat (like a normal radiator)

Illustration

This illustrates the

- Water heating coil
- Coil bracket
- Insulation

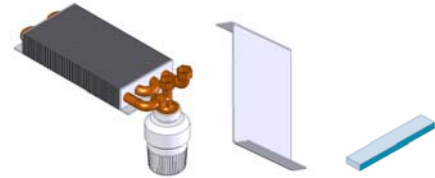

Tools

No special tools needed.

Procedure

Follow this procedure to mount the water heating coil:

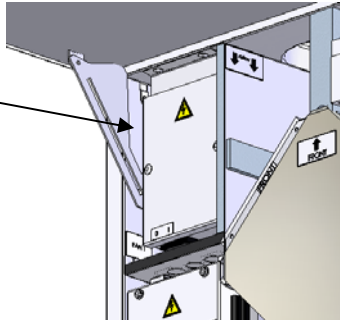
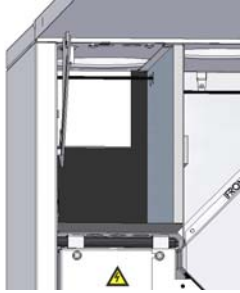
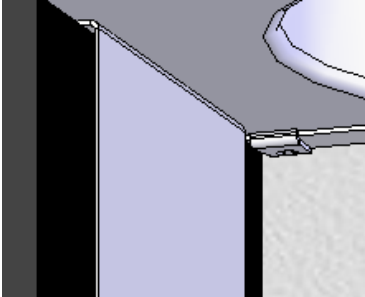
Step	Action
1	<p>Open the front cover and dismount the heating element</p> 
2	<p>Mount the coil bracket on the back wall of the unit by pressing the upper edge in over the insulation</p>  

Continued overleaf

Mounting kit, water heating coil, *continued*

Procedure, *continued*

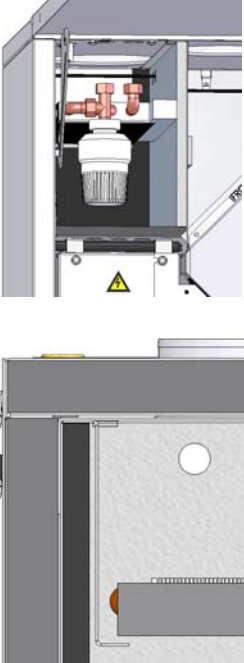
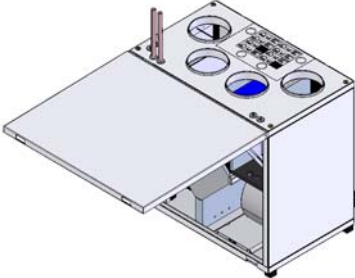
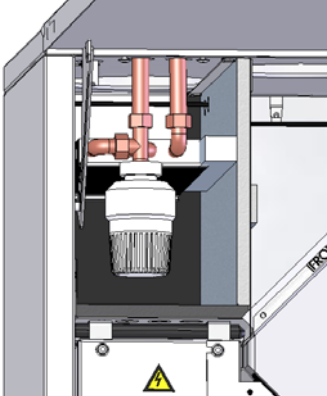
Step	Action	
3	<p>Mount the water heating coil in the HXV 5 unit</p> <p>The back end of the heating coil must rest on the coil bracket (picture seen from the side)</p>	
4	<p>Push two ½" pipes through the top openings</p>	
5	<p>Tighten the coil to the two ½" pipes</p>	
6	<p>Close the front cover and start the unit</p>	

DE Mounting kit, Wasserheizfläche

Einleitung

Die Wasserheizfläche passt zur HXV 5.

Die Wasserheizfläche wird nicht an die Steuerung angeschlossen, sondern hat statt dessen ein eigenes Thermostat (wie ein normaler Heizkörper)

Abbildung

Gezeigt werden:

- Wasserheizfläche
- Beschlag
- Isolierung

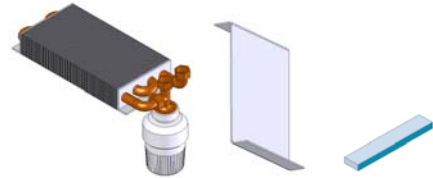

Werkzeug

Spezialwerkzeug wird nicht benötigt.

Vorgehensweise

Die Montage der Wasserheizfläche ist wie folgt vorzunehmen:

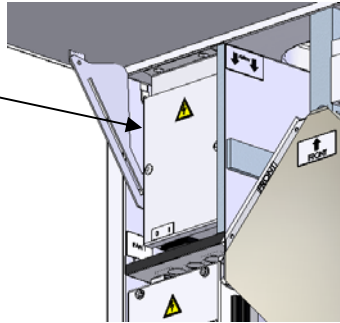
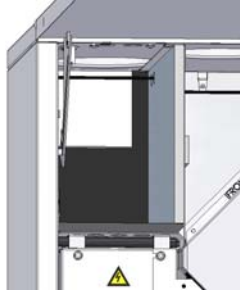
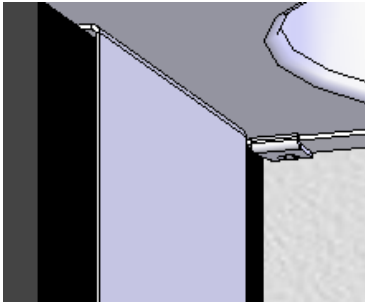
Schritt	Tätigkeit
1	Die Fronttür öffnen und das Heizelement demontieren 
2	Den Beschlag an der Rückwand der HXV 5 montieren, indem man die obere Kante über die Isolierung drückt  

Fortsetzung auf der nächsten Seite

Mounting kit, Wasserheizfläche, *fortgesetzt*

Vorgehensweise,
fortgesetzt

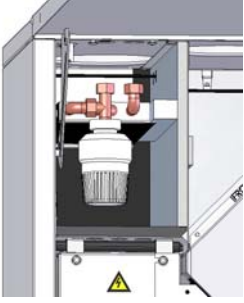
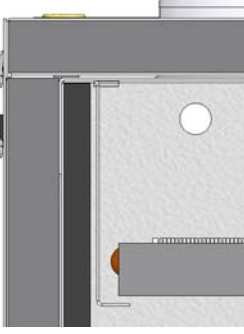
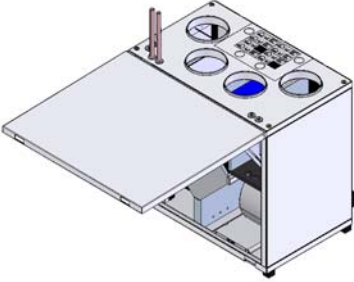
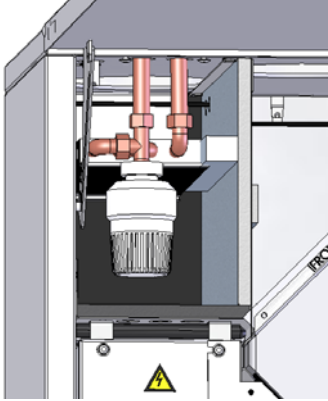
Schritt	Tätigkeit
3	<p>Die Wasserheizfläche in der HXV 5 montieren</p>  <p>Das hintere Ende der Wasserheizfläche soll auf dem Beschlag aufliegen (die Zeichnung zeigt eine Ansicht von der Seite)</p> 
4	<p>Zwei ½" Rohre durch die oberen Öffnungen drücken</p> 
5	<p>Die Fläche an den beiden ½" Rohren befestigen</p> 
6	<p>Die Fronttür schließen und die HXV 5 starten</p>